

# Rituel

par Pur Béton

## CuV 84B

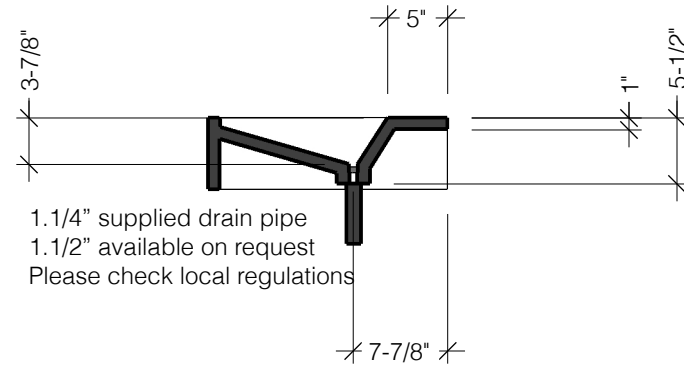
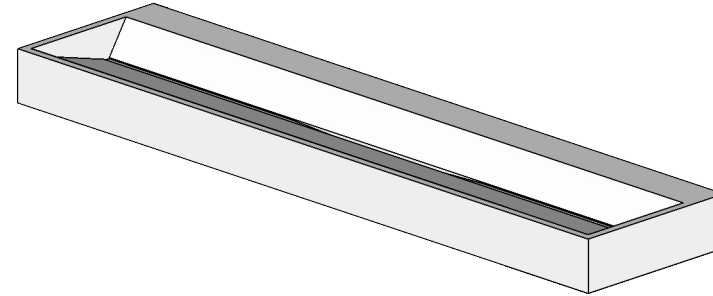

1.1/4" supplied drain pipe  
 1.1/2" available on request  
 Please check local regulations

Section A-A  
 not to scale

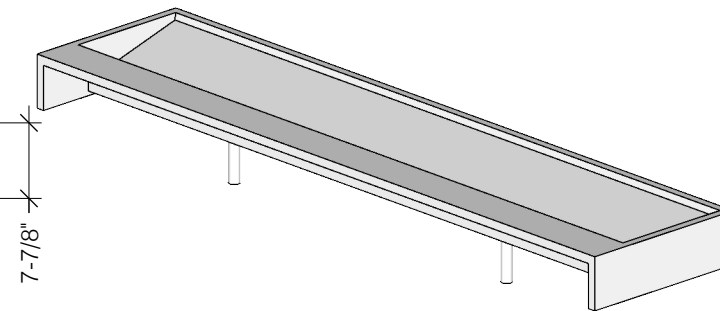

### General notes

Pur Béton work to tolerances of +/- 1/8" on all dimensions. It is the responsibility of the client to verify that all dimensions and said tolerances are suitable for the purpose of the project.

### Tap holes for surface mounted taps.

Pur Béton work to tolerances of +/- 1/4" on all positioning and hole diameters of taps holes.

It is the client responsibility to specify the proper hole patterns and positioning necessary for proper fit of taps.

A supplemental drawing will then be issued by Pur Béton and a signature will be asked to confirm positioning of hole pattern prior to manufacturing.

### Product description:

Concrete bathroom trough sink

Suitable for wall or surface mounting.  
 Design for use with surface mounted taps.  
 Compatible with all standard taps.  
 Available with or without brackets.  
 Supplied with 2 x 5" long, 1.1/4" dia. chrome drain pipe.  
 1.1/2" available on request  
 Please check local regulations

Length: 84"  
 Width: 20"  
 Height: 6"  
 Weight: 235 lbs

### CuV 84B



178 Rang Duncan  
 St-Chrysostome (Québec)  
 Canada J0S 1R0  
**514 886-2444**  
 info@purbeton.com  
**purbeton.com**